

# SX1308

Boost Converter

## Features

### Claimed specification

- Input voltage: 2-24V
- Output voltage: 2-28V, adjustable
- Size: 16mm x 23mm x 14mm
- Max. output current: 2A
- 1.2MHz switching frequency.

### Additional information

- Starts working at about 3 V
- 1 - 9mA idle current
- Doesn't come close to 2A output current.
- Output Voltage starts to decrease when the input current comes near 2A.
- Output voltage regulation is not very stable.

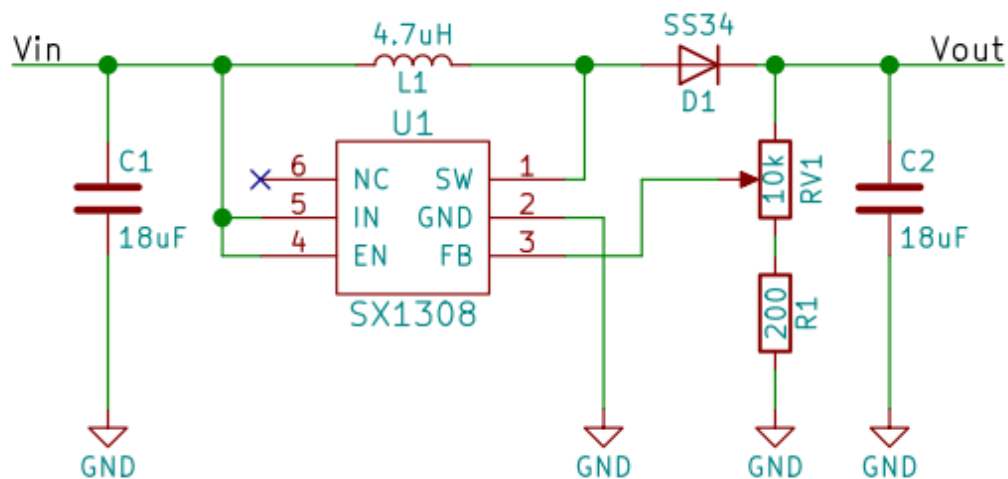
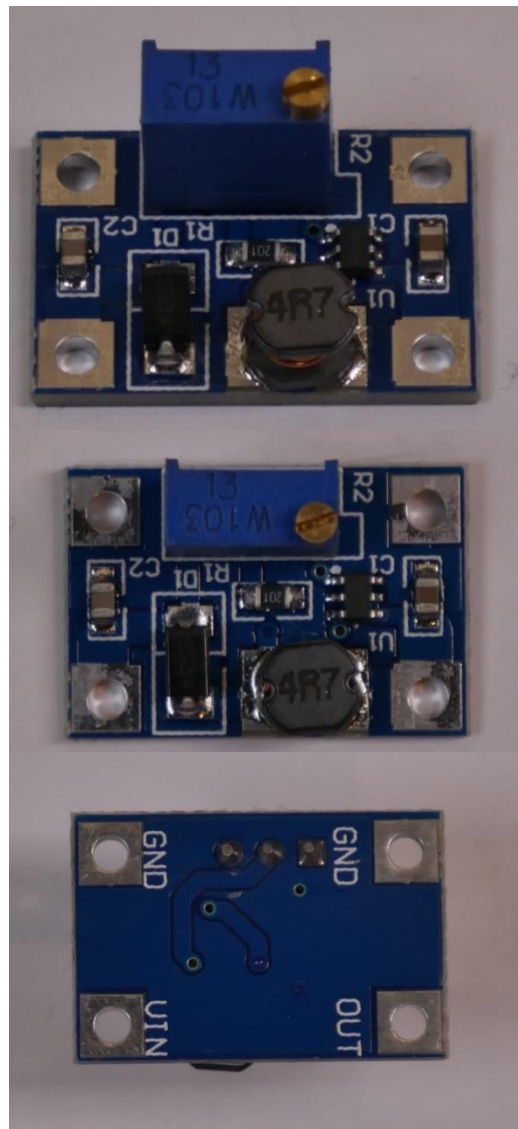

# SX1308

Boost Converter

## Efficiency

5V Output

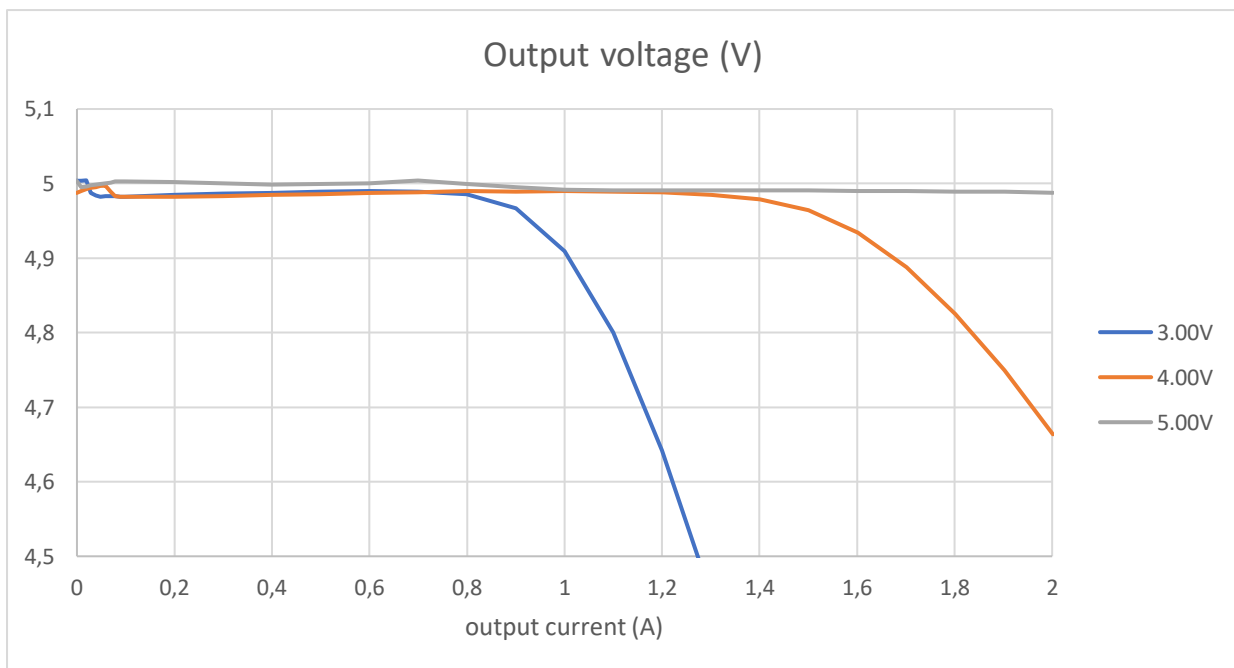
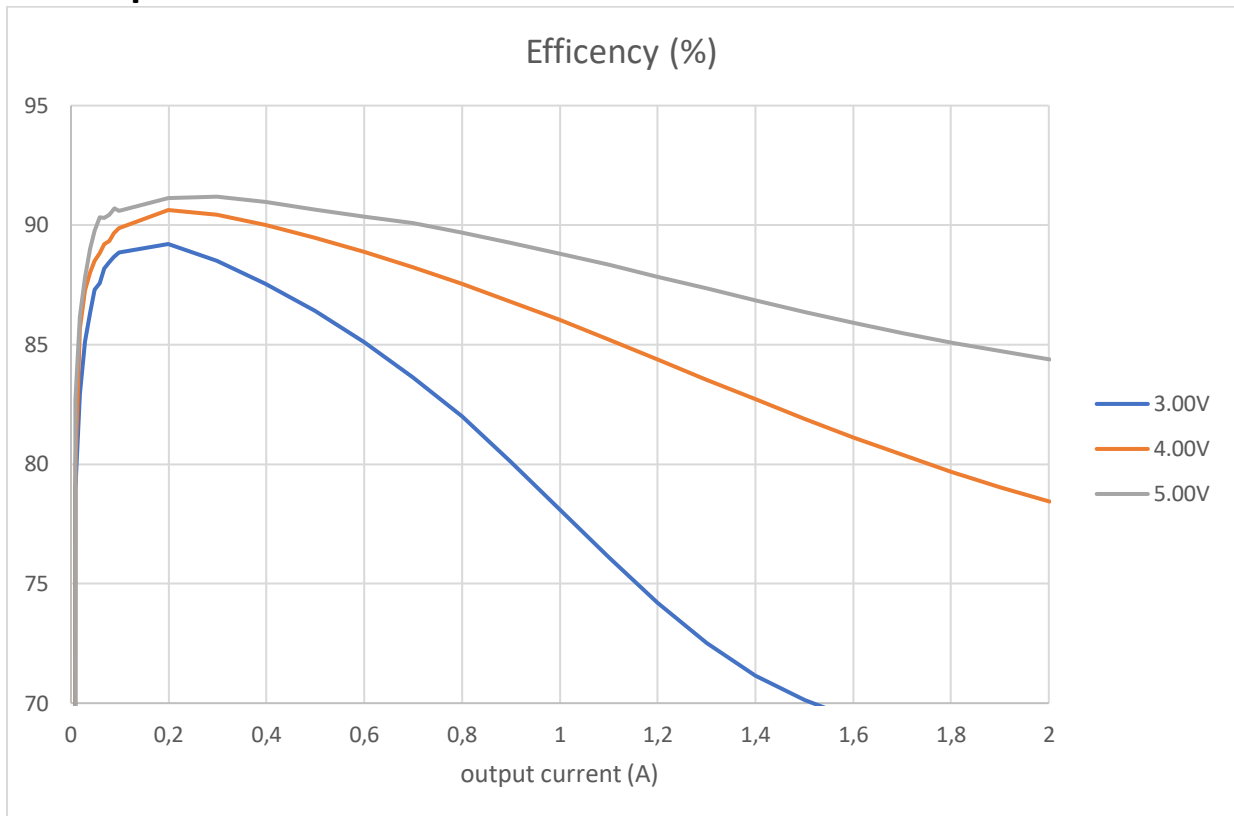

# SX1308

## Boost Converter

### 9V Output

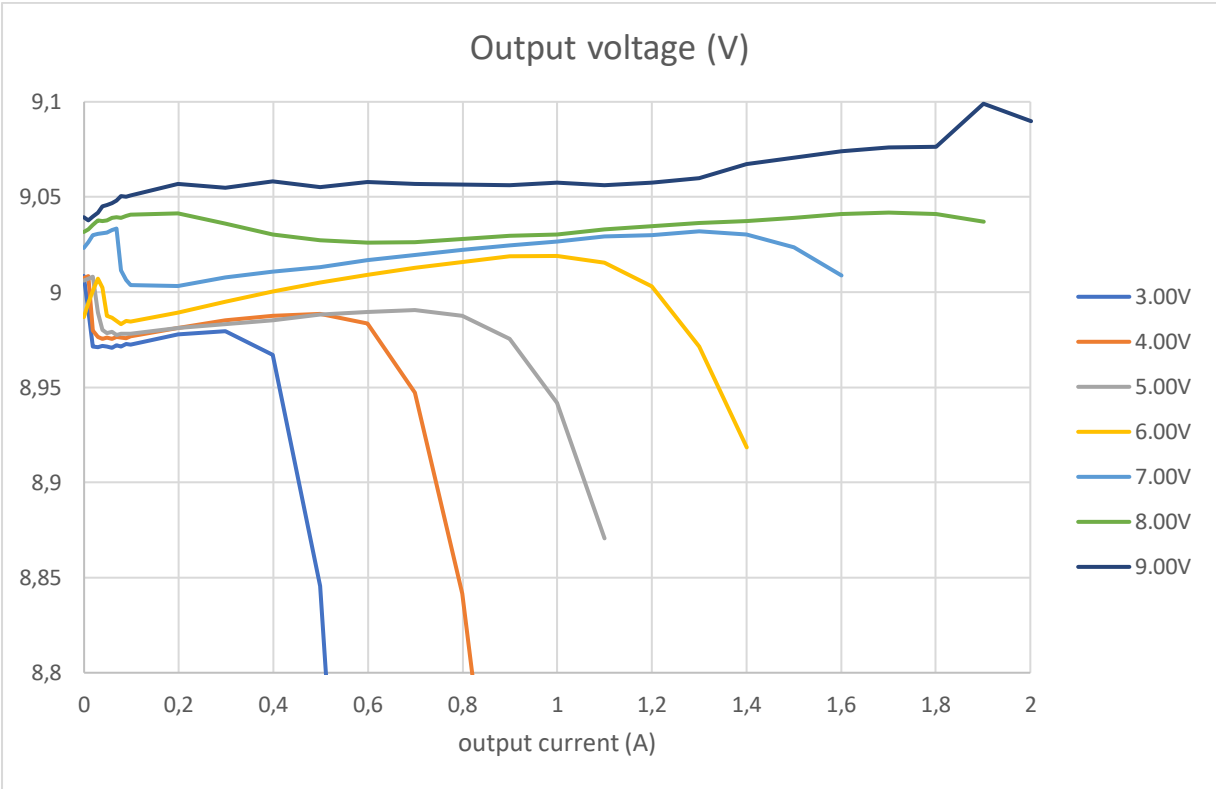
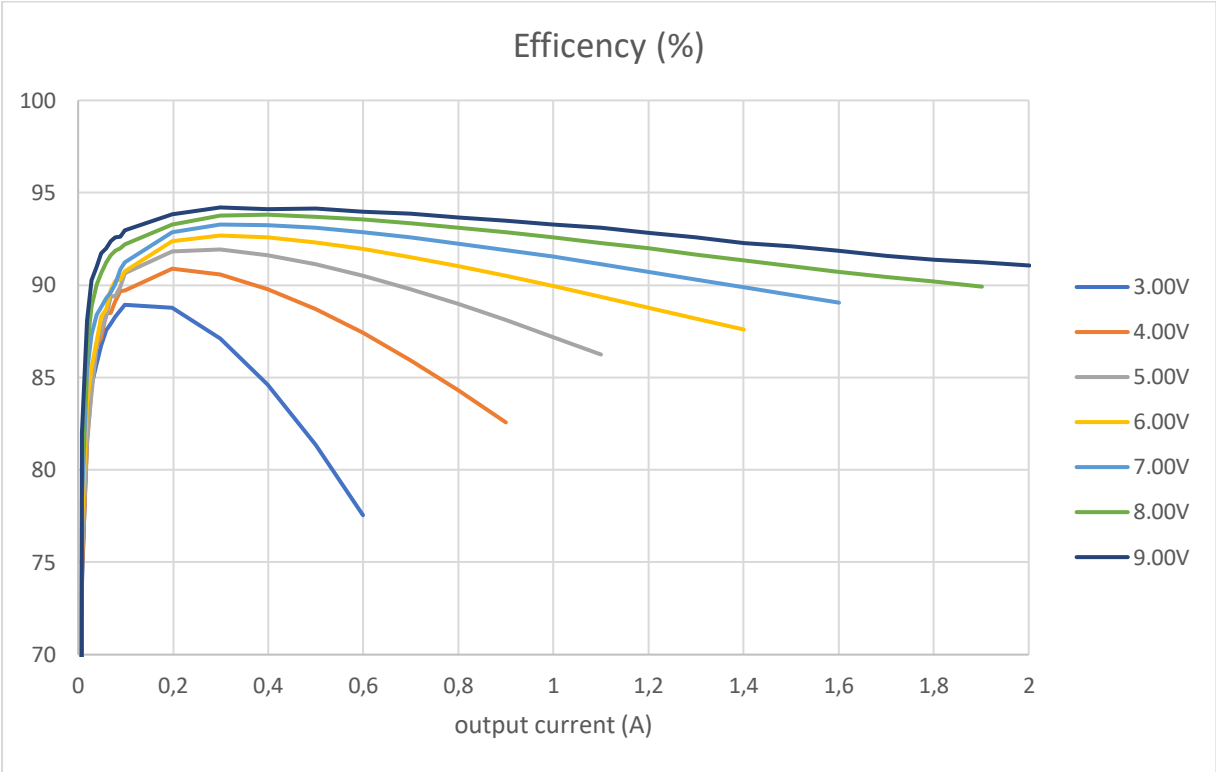

# SX1308

## Boost Converter

### 12V Output

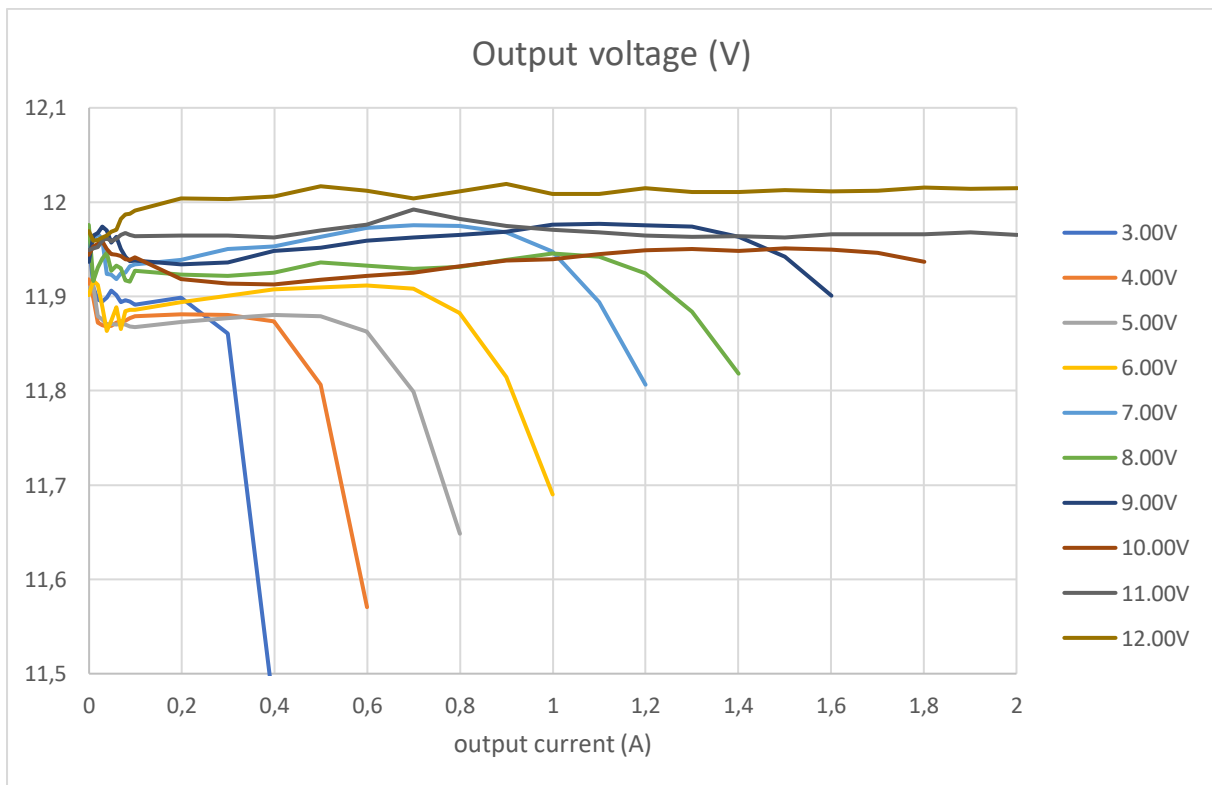
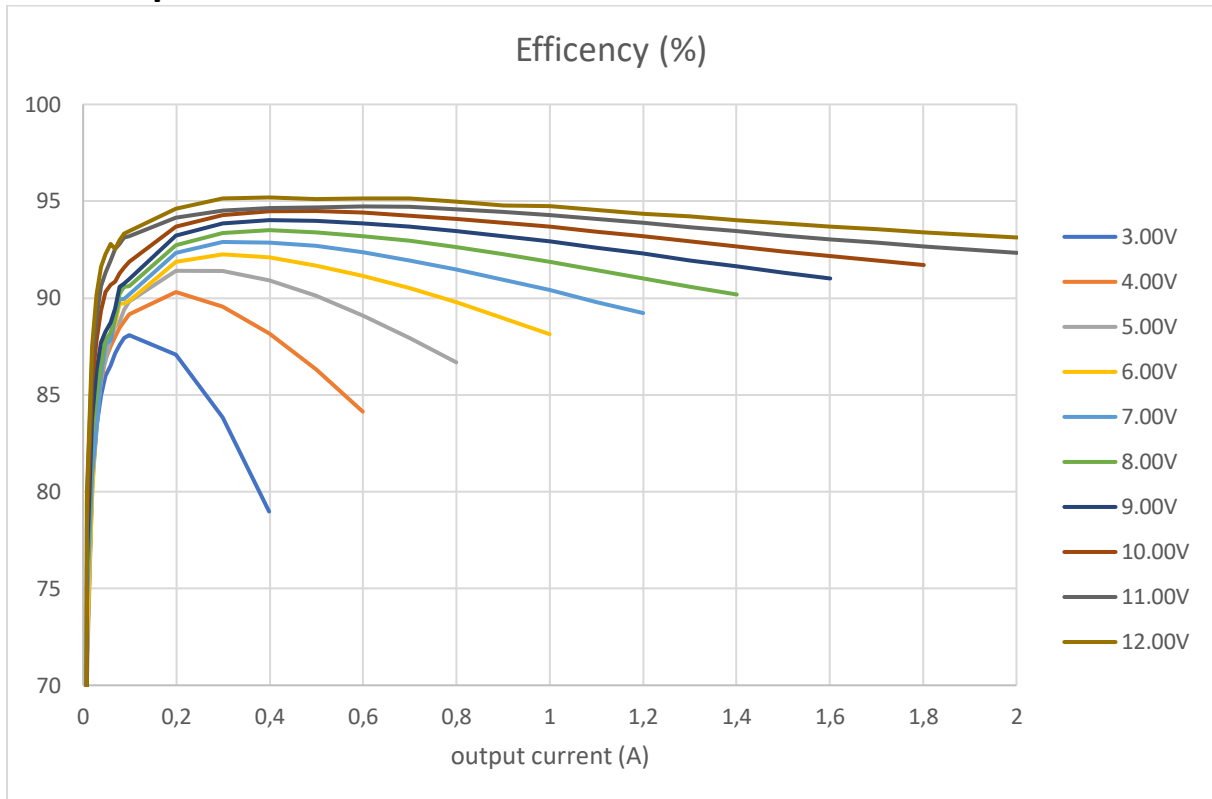

# SX1308

## Boost Converter

### 15V Output

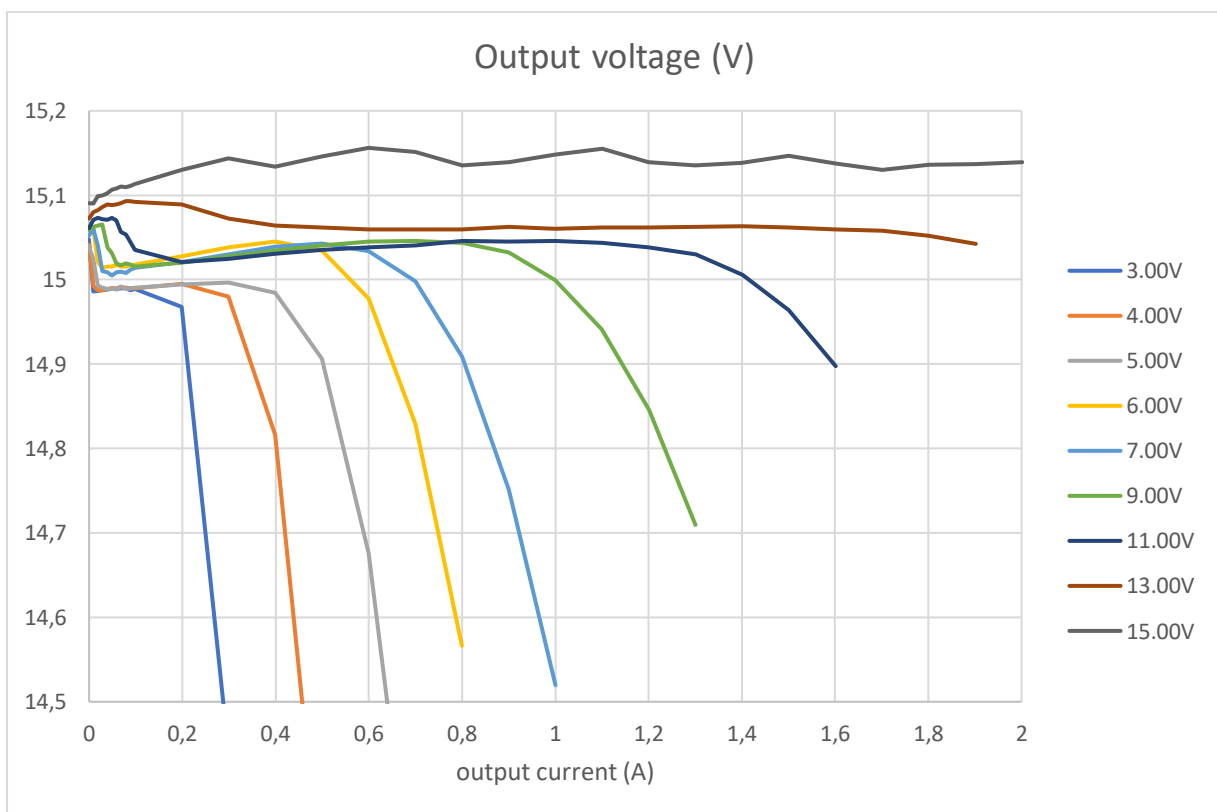
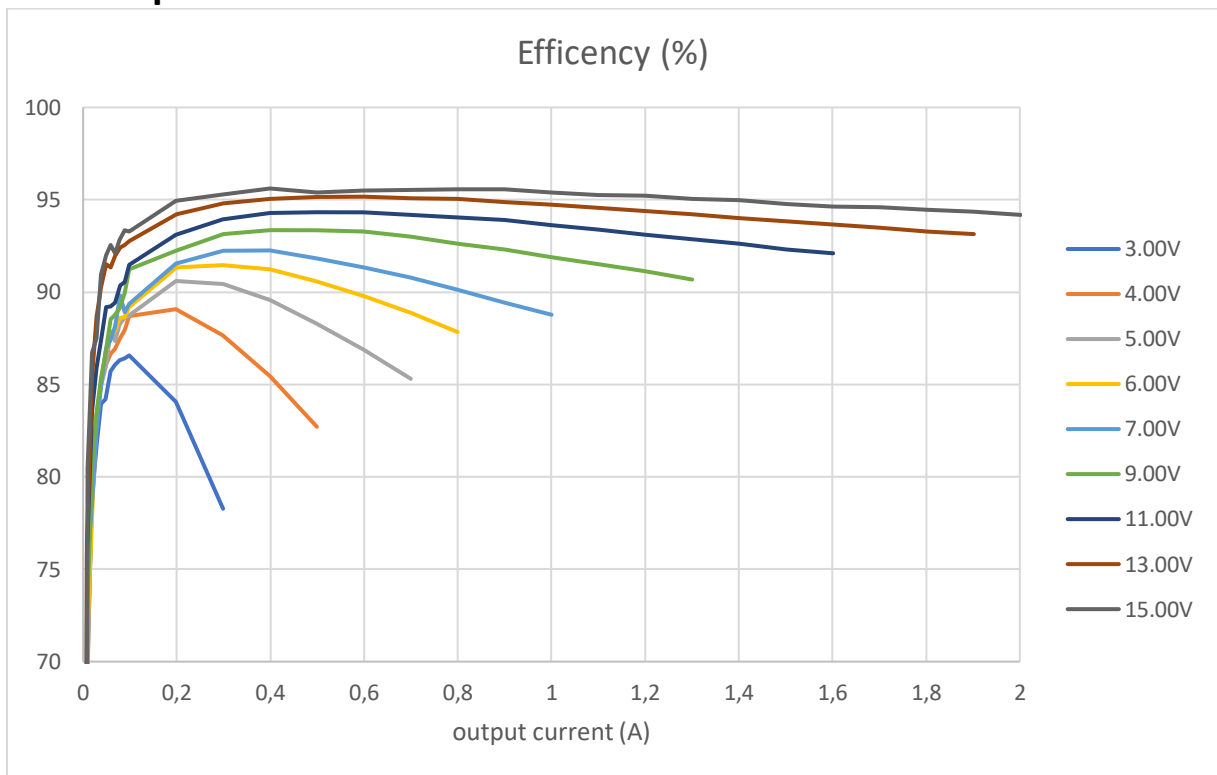

# SX1308

## Boost Converter

### 20V Output

